

Introduction to Network Security

Chapter 11

Remote Access Security

Dr. Doug Jacobson - Introduction to
Network Security - 2009

1

Topics

- Remote Access
 - Telnet
 - Rlogin
 - X-Windows
 - FTP
 - General Countermeasures
- Peer-to-Peer Protocols
- Anonymous services & Privacy
- General countermeasures

Dr. Doug Jacobson - Introduction to
Network Security - 2009

2

Telnet

TELNET: a Virtual Terminal Protocol that provides interactive access to remote computers

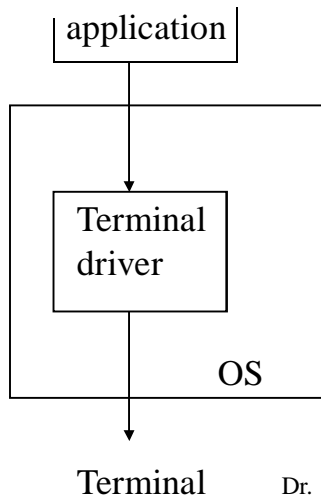

The protocol defines:

- Format of data
- How control signals are passed and how to distinguish them from data
- Data transfer mode (half/full duplex, sync/async)
- How out-of-band signals are passed
- How data delivery is controlled

Telnet

NVT – Network Virtual Terminal

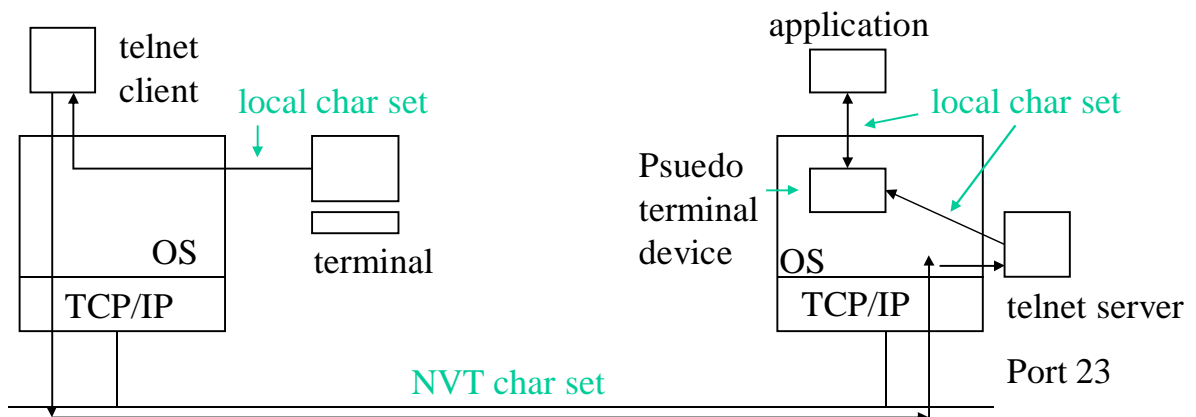

Local charsets of different OS's may not be compatible. When sending over the network, the local charset is translated to the common NVT charset by the telnet client. The telnet server then translates the NVT charset to the local charset

Telnet

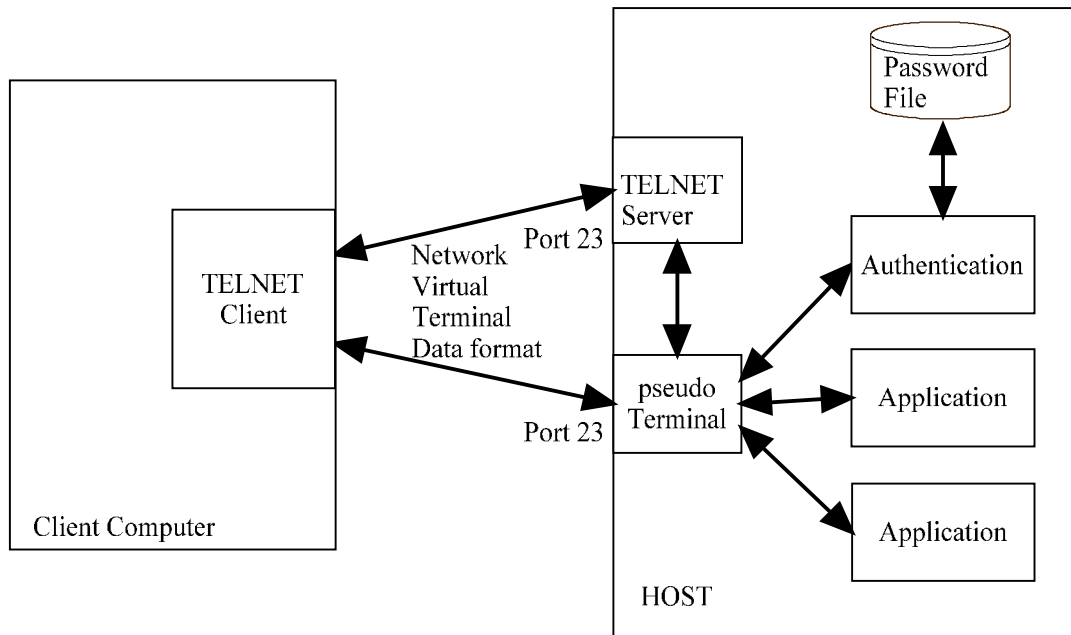

Dr. Doug Jacobson - Introduction to
Network Security - 2009

5

Telnet

The virtual terminal consists of a display and a printer

- Display
 - Characters are 7 bit ASCII
 - Operates in scroll mode with unlimited line length, unlimited lines per page
 - Must be able to generate control signals:
 - Are You There
 - Interrupt Process
 - Abort Output
 - Erase Character
 - Erase line
 - Break
- Printer
 - Has unspecified line width and page length
 - Can print the 95 ASCII graphic characters
 - Can respond to the control codes:
 - NUL
 - Line Feed
 - Carriage return

Dr. Doug Jacobson - Introduction to
Network Security - 2009

6

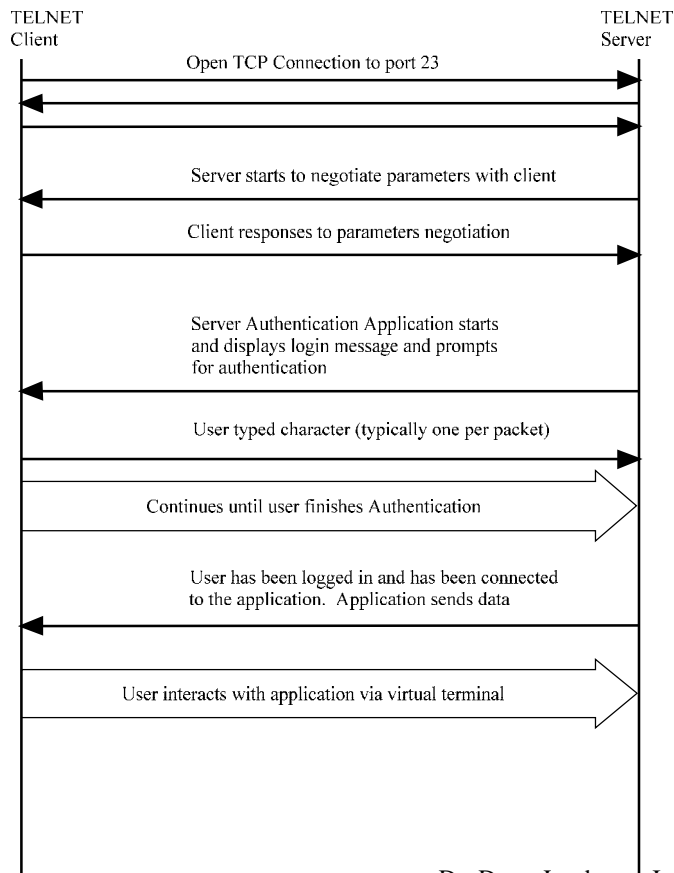

Telnet

Dr. Doug Jacobson - Introduction to Network Security - 2009

7

Telnet Commands

Definition	Abbr	code
End of subnegotiation	SE	240
No Operation	NOP	241
Data Mark: A stream sync character	DM	242
Break	BRK	243
Interrupt Process		IOP 244
Abort Output	AO	245
Are You There	AYT	246
Erase Character		EC 247
Go Ahead: turn line around for half duplex		GA 249
Begin subnegotiation	SB	250
WILL		251
WONT		252
DO		253
DON'T		254
Interpret as CMD	IAC	255

Dr. Doug Jacobson - Introduction to Network Security - 2009

8

Telnet Commands

How to mix user data and commands:

user data:

0	7 bit ASCII
---	-------------

command:

1	7 bits
---	--------

There is a special command to transfer 8 byte data

Telnet Options

- Options can be negotiated by telnet processes
- New options can be accommodated since they are not part of the standard
- Three categories
 1. Enhance, change, and refine NVT characteristics (e.g. line width)
 2. Change transfer protocol (e.g. suppress GO AHEAD)
 3. Information to be passed to the host (e.g. status, terminal type)

Telnet Options

This is just a subset of the options defined in many different RFC's:

ID	Name	RFC	Category
0	Binary transmission	856	2
1	echo	857	1
5	status	859	3
8	output line width		1
9	Output page size		1
10	Output <cr> disposition	652	1
24	terminal type	930	3
25	End of record	885	3

Telnet Negotiation

Option negotiation rules:

- May reject a request to enable an option
- Must accept a request to disable an option
- Options are not enabled until negotiation is complete
- Never negotiate an option that is already true

Telnet Negotiation

Option negotiation commands:

- WILL Sender wants to enable the option
- WONT Sender does not want to enable the option
- DO Sender would like the other side to enable the option
- DON'T Sender would not like the other side to enable the option

Example 1: Side A wants to enable ECHO (857), side B agrees

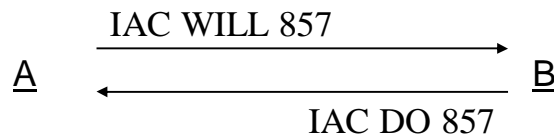

Dr. Doug Jacobson - Introduction to
Network Security - 2009

13

Telnet Negotiation

- Example 2: A would like B to enable ECHO, B agrees

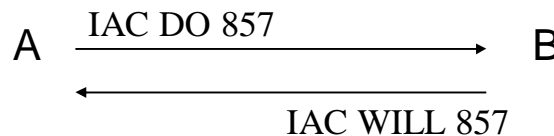

- Example 3: A would like B to enable ECHO, but B does not agree

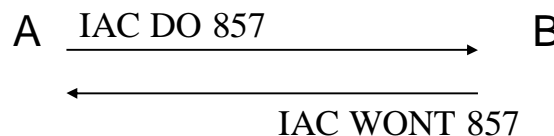

Dr. Doug Jacobson - Introduction to
Network Security - 2009

14

Telnet Negotiation

- Example 4: A would like to disable echo, B MUST agree

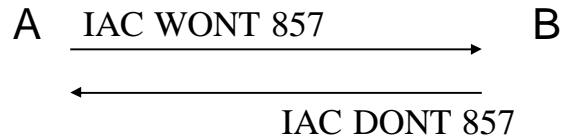

- Example 5: A would like B to disable echo, B must agree

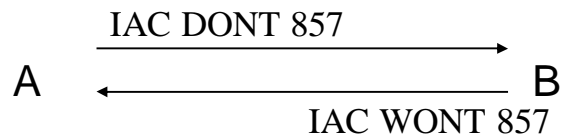

Telnet Negotiation

Suboptions

SE 240 suboption end
SB 241 suboption begin

Example: A wants to set the terminal type (2Y) to vt100

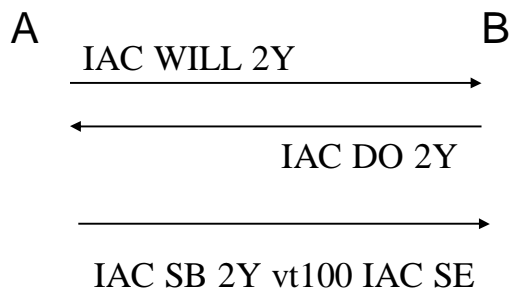

Direction	Data	Comments
C → S	0xff 0xfd 0x01 0xff 0xfd 0x22 0xff 0xfb 0x05	IAC, Do Echo (request client echoes) IAC, Do linemode (request client sends a line at a time) IAC, Will Status (server wishes to send status info)
C → S	0xff 0xfb 0x01 0xff 0xfc 0x22 0xff 0xfe 0x05	IAC, Will Echo (client will echo characters) IAC, Won't linemode (Client will not do linemode) IAC, Don't Status (client does not want server to send status information)
C → S	0xff 0xfe 0x01 0xff 0xfb 0x01	IAC, Don't Echo (tell client not to echo) IAC, Will Echo (tell client server will echo)
C → S	0xff 0xfc 0x01 0xff 0xfd 0x01	IAC, Won't Echo (tell server client will not echo) IAC, Do Echo (tell server it is OK to echo)
C → S	\r\n Login:	Send authentication application prompt
C → S	j	First char of user name
C → S	j	Echo of the character
		Repeat until enter key is pressed
C → S	\r\n	Send carriage return + linefeed
C → S	\r\n	Echo carriage return + linefeed
C → S	Password:	Send authentication application prompt
C → S	p	First char of password (server will not echo)
		Repeat until enter key is pressed
C → S	\r\n	Send carriage return + linefeed
C → S	\r\n	Echo carriage return + linefeed
C → S		User is now connected and server application will send message.

Rlogin

- Remote login (rlogin)
- Similar to telnet, but much simpler
- Designed for unix to unix communication
- Possible for hosts to login without a password
- Uses port 513
- Sequence:
 - Client sends: \0
local login name
\0
server login name
\0
terminal type
\0
 - Server sends: \0

Rlogin

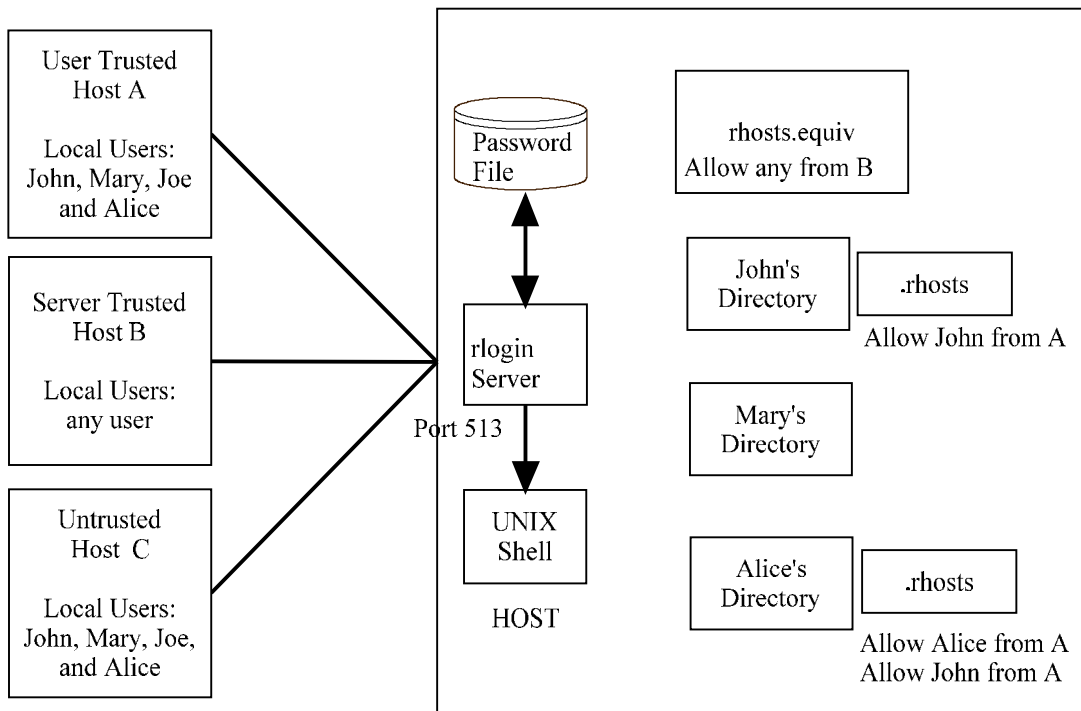

rlogin server trust

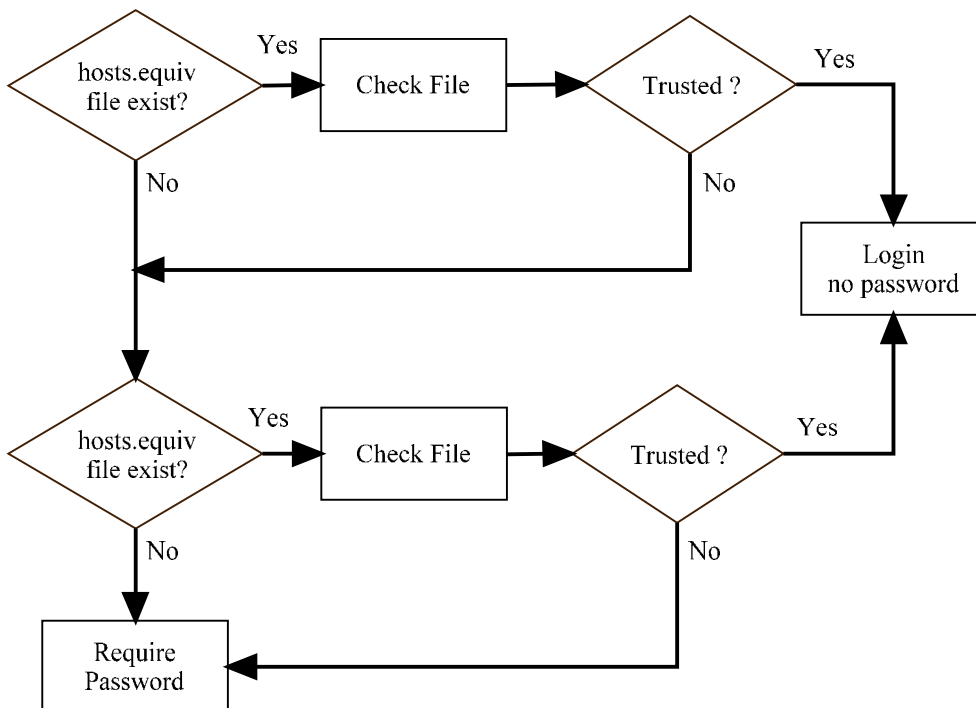

rlogin trust

Client host	Client side user	Server side user	Result	
A	John	John	Trusted	
		Mary	Not Trusted	
		Alice	Trusted	
		Mary	John	Not Trusted
			Mary	Not Trusted
			Alice	Not Trusted
	Joe	John	Not Trusted	
		Mary	Not Trusted	
		Alice	Not Trusted	
	Alice	John	Not Trusted	
		Mary	Not Trusted	
		Alice	Trusted	
B	Any User	Any User	Trusted	

rlogin trust

Client host	Client side user	Server side user	Result
C	John	John	Not Trusted
		Mary	Not Trusted
		Alice	Not Trusted
	Mary	John	Not Trusted
		Mary	Not Trusted
		Alice	Not Trusted
	Joe	John	Not Trusted
		Mary	Not Trusted
		Alice	Not Trusted
	Alice	John	Not Trusted
		Mary	Not Trusted
		Alice	Not Trusted

Rlogin commands

- Commands are distinguished by 0xFF
 - Remote flow control 0x10
 - Local flow control 0x20
 - Window size 0x80
(asks client for current window size)
- Escape character: ~ ^d
- Everything is sent in clear text

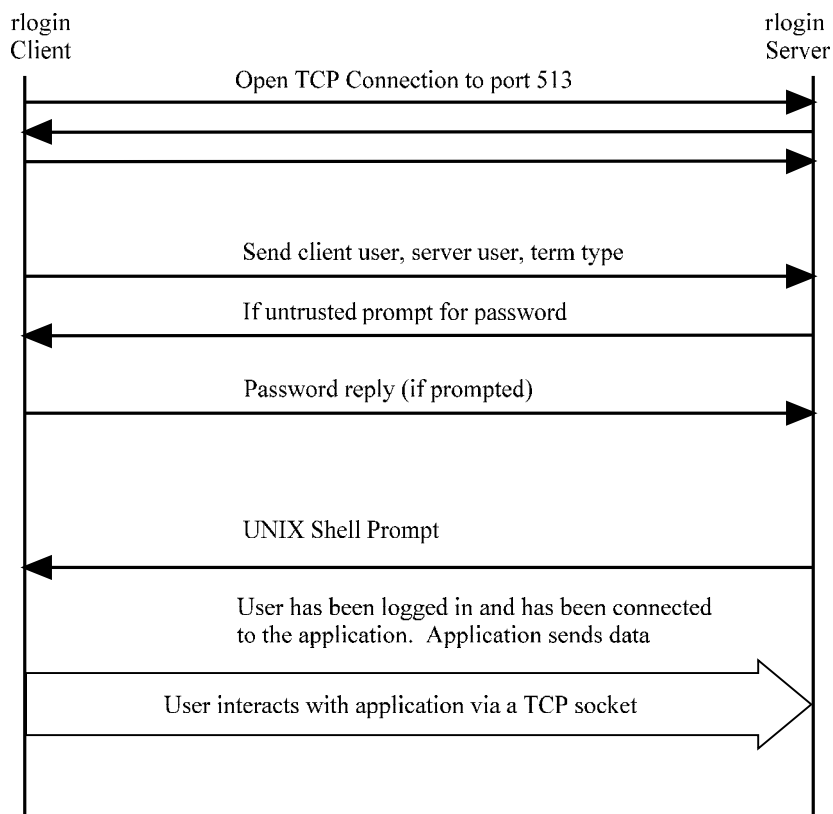

rlogin

rlogin

Direction	Data	Comments
C → S	john 0x00 john 0x00 xterm\34800 0x00	Client side username Server side username Terminal type and speed
		If authentication is required (user is untrusted)
C → S	Password:	Prompt for password
C → S	p	First char of password (server will not echo)
		Repeat until enter key is pressed
C → S	\r	Send carriage return
C → S	\r\n	Echo carriage return + linefeed
		If authentication worked or user was trusted
C → S	Data from server	User is now connected and server will display the UNIX shell prompt.

X windows

- The user sits on the server side of X windows
 - Usually telnet into client and start X window client
 - X windows then starts and the client authenticates to the X windows server
 - X windows sends information in clear text

X-windows

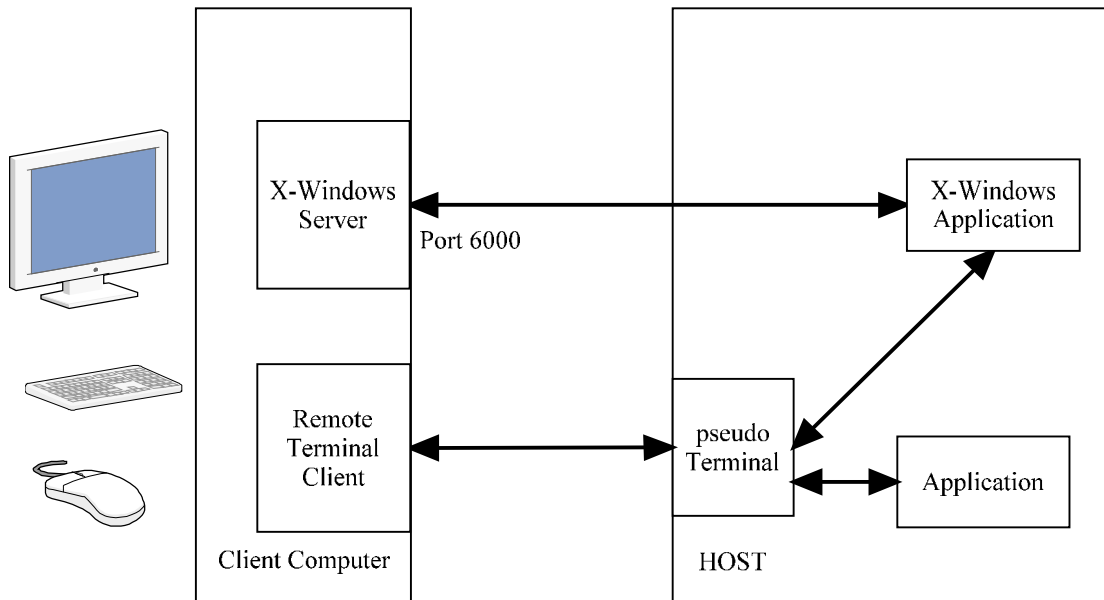

Communication

- In order for two programs to communicate in Unix, a pipe is created between the two processes
 - Pipe works like it sounds, put data in on one side comes out the other
 - Pipe created in the tmp directory
- Port 6000

Local X-Windows

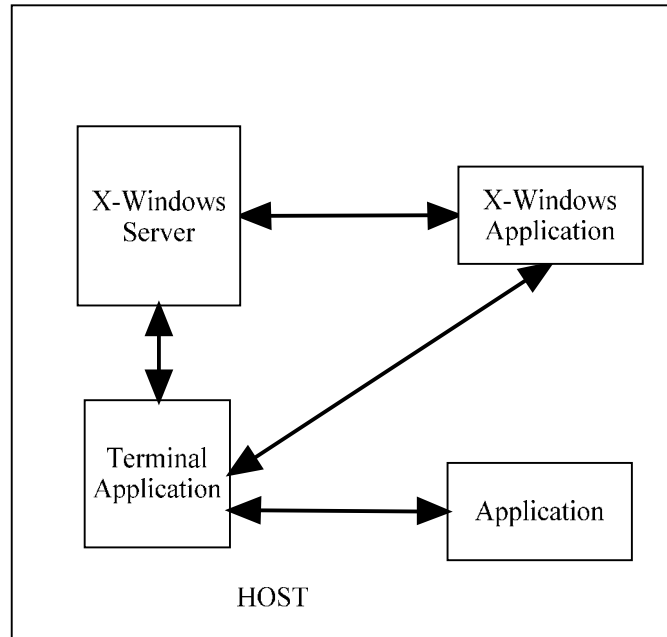
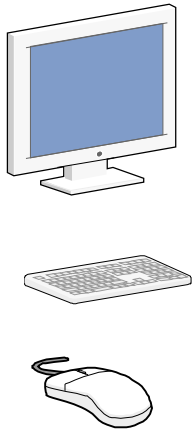

Dr. Doug Jacobson - Introduction to
Network Security - 2009

29

Server Side

- X windows offers up your computer to the outside world to manipulate
- Pc also has public domain X windows programs
- Xhost determines who can connect to your server
 - Xhost + would allow all to connect to one's X windows
- X windows is designed to allow applications control over the display
- Client side
 - How does client know which server to connect to
 - Variable called display
 - :0.0 display means local display
 - The second number is the monitor
 - If remote machine:0.0 which is set on the client
 - Tells X windows to point to server

Dr. Doug Jacobson - Introduction to
Network Security - 2009

30

Server Side cont...

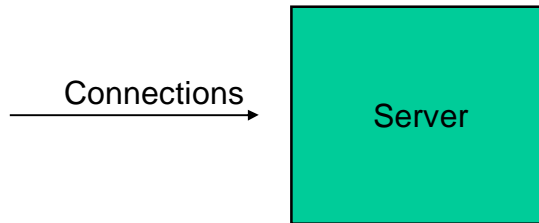

- Authentication?
 - Xhost command, indicates who can connect to one's server, which is IP address based authentication
 - Xhost + allow all connections
 - Xhost - allows nobody
- Command set is designed to allow total control over input and display
 - Through X windows, hackers could
 - Capture screen
 - Capture keystrokes
 - Create, destroy windows
 - Enter key strokes into windows

Local Side

- Pipe
 - /tmp/.X11 ...
 - Tmp directory is shared and is world read writable
 - Can do denial of service by deleting the pipe in the tmp directory
 - No new clients can connect
 - Current clients stay connected

Header Based

- For Telnet and rlogin there is not much of a header.
- X-Windows there is possible buffer overflow attacks.

Protocol Based

- Telnet and rlogin have a simple protocol and there is not any attacks, other than telnet can be used to connect to any service (not really a flaw)
- X-Windows has some issues with the protocol since the protocol gives the application control over the remote computer.

Authentication Based

- Telnet offers access to the remote machine and to the login prompt
- Rlogin does not need password unless setup correctly. Uses IP address for authenticator
- X-Windows
 - server can allow any machine to control it based on the IP address
 - Client uses machine authentication to allow a user to run the application

Authentication Stepping stone

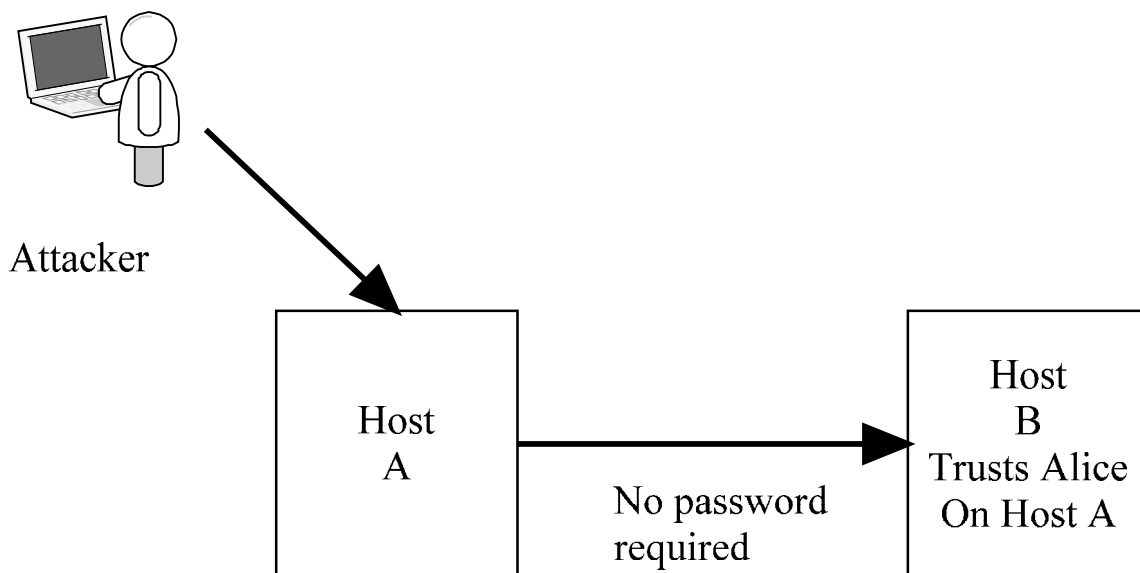

Traffic Based

- All three are clear text (sniffing)
 - Usernames & Password
 - Commands and text

FTP

- Commonly used files transfer protocol
- Uses a command channel and a data channel
- Command channel is used to control the FTP session and remains open for the entire FTP session.
- The data channel is used to transfer data between the client and the server
- A new data channel connection is opened for each data transfer.

FTP Command & Data Channels

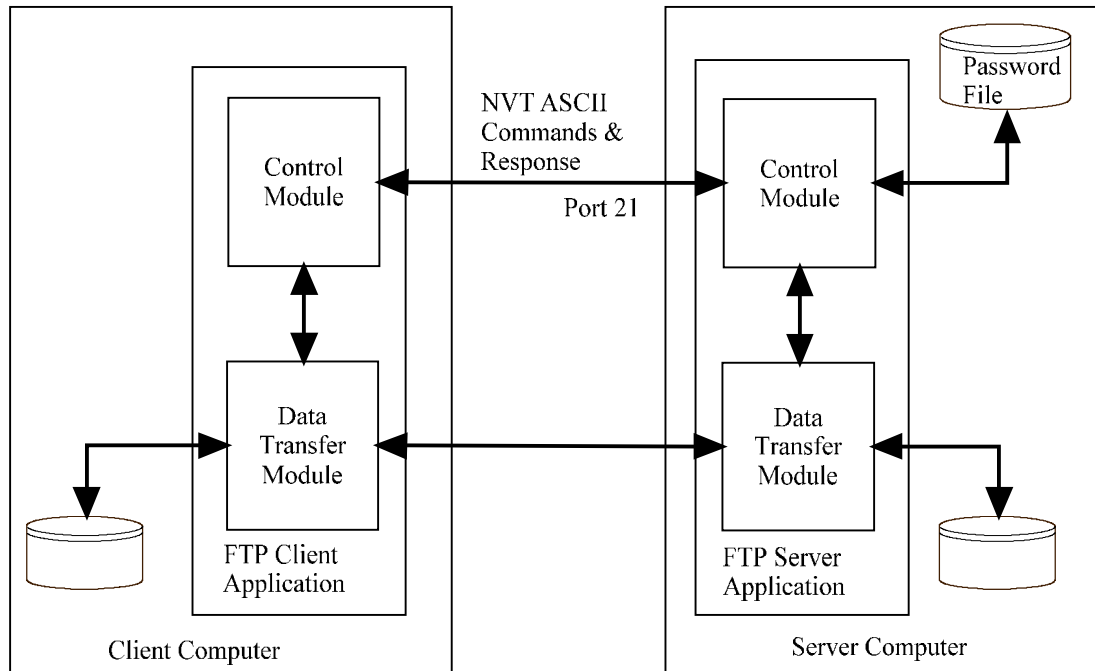

Dr. Doug Jacobson - Introduction to
Network Security - 2009

39

FTP Commands

- The next slide lists the common FTP commands
- The commands are sent as ASCII text and the responses to the commands are also ASCII.

Dr. Doug Jacobson - Introduction to
Network Security - 2009

40

Command	Action
Authentication	
USER username	Send the username to the server
PASS password	Send the user password to the server
QUIT	Finish session
File Management	
CWD directory_name	Change directory on the server
CDUP	Change to the parent directory on the server
DELE filename	Delete the file from the server
LIST directory_name	List the files on the server
MKD directory_name	Make a new directory on the server
PWD	Print the current directory on the server
RMD directory_name	Delete a directory from the server
RNFR old_file_name	Name of file on the server to be renamed
RNTO new_file_name	Name of file on the server to rename the file to
Data Format	
TYPE (A, I)	Set data transfer type, A=ASCII, I=Image
Data port	
PORT 6 digit identifier	Client sends the port number for the server to connect to for the data transfer
PASV	Server send the port number for the client to connect to for the data transfer
File Transfer	
RETR filename(s)	Transfer the file(s) from the server to the client using the data connection
STOR filename(s)	Transfer the file(s) from the client to the server using the data connection
Miscellaneous	
HELP	Server will return information

41

Response codes

Code	Response Status	Code	Response type
1XX	Positive Preliminary Reply – Indicates the server will respond with another response code before the client can continue.	X0X	Syntax Error or unimplemented commands
2XX	Positive Completion Reply – Indicates the command was successful and a new command can be issued.	X1X	Information – reply to a request for information
3XX	Positive Intermediate Reply – Indicates the command was successful, but the action is held up pending receipt of another command from the client.	X2X	Connections – Reply to a request for connection
4XX	Transient Negative Completion Reply – Indicates the command was not accepted, however the error is temporary.	X3X	Authentication – Reply to authentication commands
5XX	Permanent Negative Completion Reply – Indicates the command was not accepted.	X4X	Unspecified
		X5X	File System – Reply to file system based requests

Common Response Codes

Code	Responses
150	Data connection will open
200	Command acknowledgement
220	Service ready
225	Data connection open
226	Closing data connection
230	User logged in
331	User needs password
425	Cannot open data connection
500	Syntax error
530	User login failure

FTP Protocol Exchange

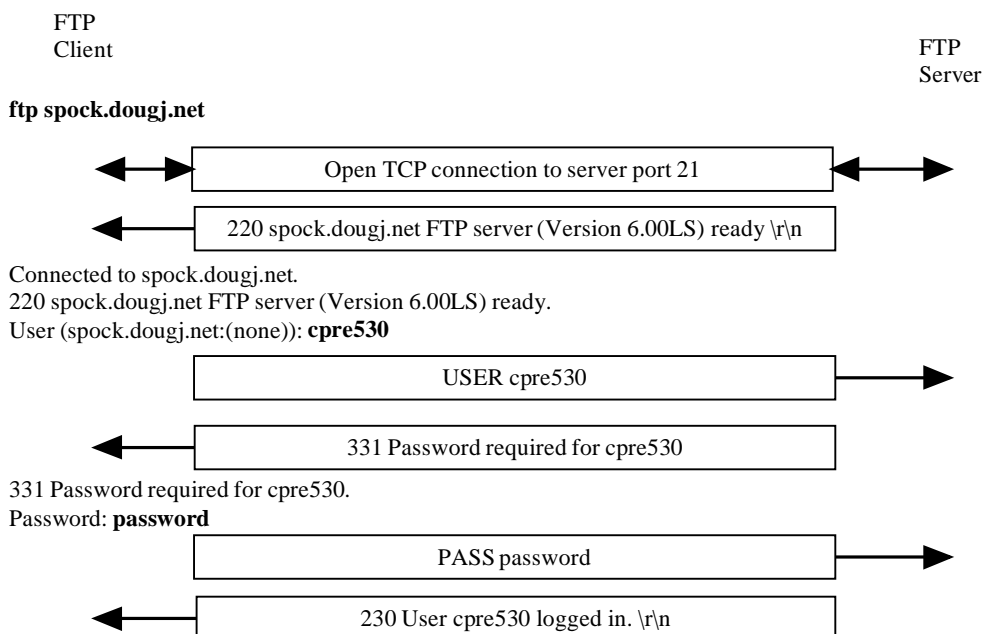

FTP Protocol Exchange

230 User cpre530 logged in.
ftp> ls

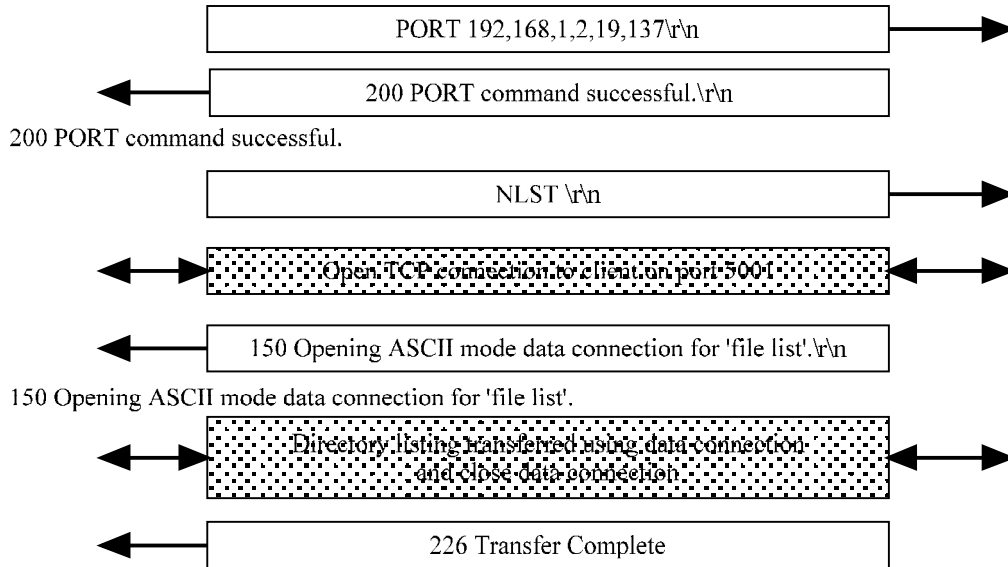

FTP Protocol Exchange

(list of files)
226 Transfer complete.
ftp: 463 bytes received in 0.00Seconds 463000.00Kbytes/sec.
ftp> quit

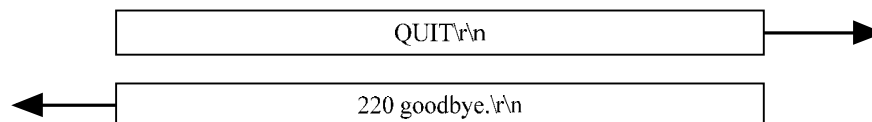

Anonymous FTP

- `$ ftp spock.dougj.net`
- Connected to spock.dougj.net.
- 220 spock.dougj.net FTP server ready.
- User (spock.dougj.net:(none)): **anonymous**
- 331 Guest login ok, type your name as password.
- Password:
- 230 Guest login ok, access restrictions apply.
- ftp>

Anonymous FTP Server

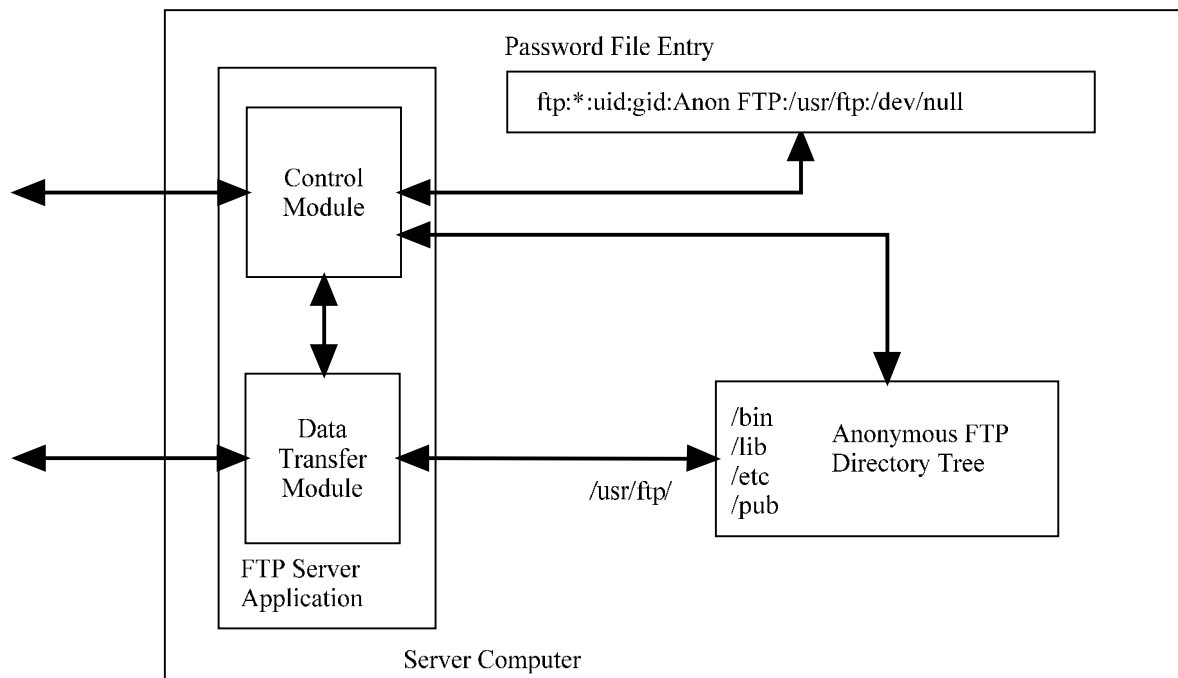

TFTP

Name (opcode)	Parameters	Function
RRQ (1)	Filename (var), 0x00 Mode (var), 0x00	Read request, mode is either netascii or octet
WRQ (2)	Filename (var), 0x00 Mode (var), 0x00	Write request, mode is either netascii or octet
DATA (3)	Block Number (2 bytes) Data (0-512 bytes)	Block number starts at 1, all blocks except the last block must be 512 bytes long. A block that is less than 512 bytes is used to indicate last block and the file transfer is done
ACK (4)	Block Number (2 bytes)	Used to acknowledge the data block
ERROR (5)	Error number (2 bytes) Error data (var), 0x00	Used to indicate an error, the error data is text data.

RCP

- Based on rlogin
- If user is trusted copy will take place
- If user is not trusted copy will not take place.

Header & Protocol Based

- FTP has problems with buffer overflows
- Not many protocol attacks
 - One is an FTP redirect attack
 - Done by telneting to an FTP server that has exploit code.
 - Use ftp to transfer the code to another server

Redirect

- **\$ telnet klingon.iseage.org 21**
- 220 klingon.iseage.org FTP server ready.
- **user anonymous**
- 331 Guest login ok, type your name as password.
- **pass doug**
- 230 Guest login ok, access restrictions apply.
- **port 192,168,1,40,0,25**
- 200 PORT command successful.
- **retr m1**
- 150 Opening ASCII mode data connection for 'm1' (84 bytes).
- 226 Transfer complete.
- **Quit**

```
File m1:  
HELO cia.gov  
MAIL FROM: badperson@cia.gov  
RCPT TO: user  
DATA  
(any mail message)  
.
```

Authentication-Based

- FTP Prompts for username and password
- Anonymous FTP with writable directories
- User based FTP server

Traffic-Based

- Clear Text
- FTP can be flooded, massive uploads or downloads

General FTP Countermeasures

- Encrypted Channels
- Encrypted copy & FTP

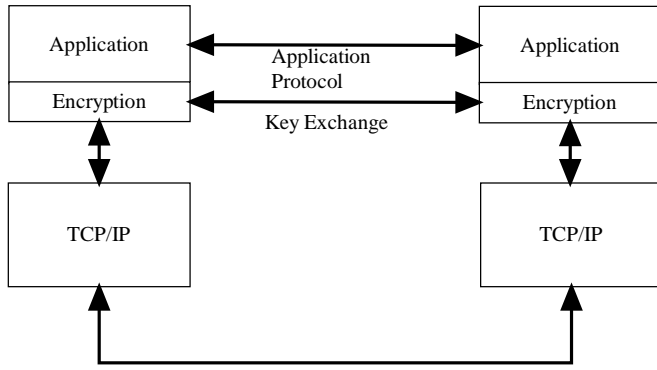

Encrypted Channels

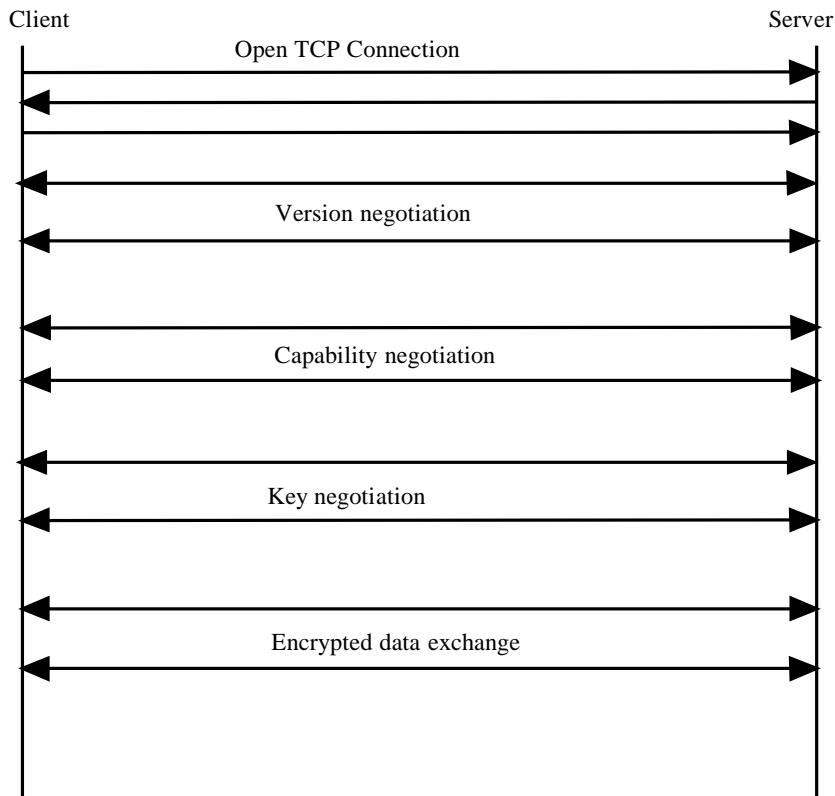
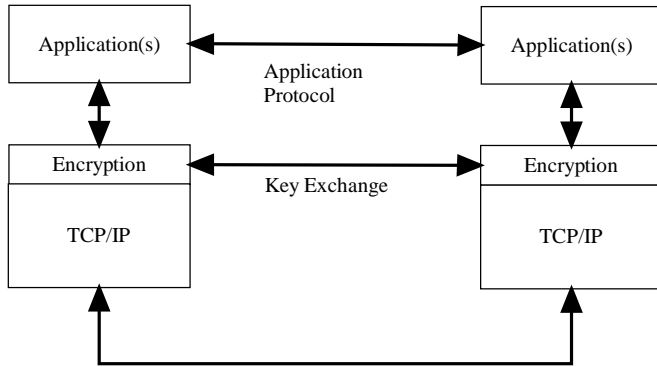

Encrypted protocols

Peer-to-Peer Topics

- We will look at examples of peer-to-peer protocols
 - Napster
 - KaZaA
 - Gnutella

Peer to peer types

- Decentralized

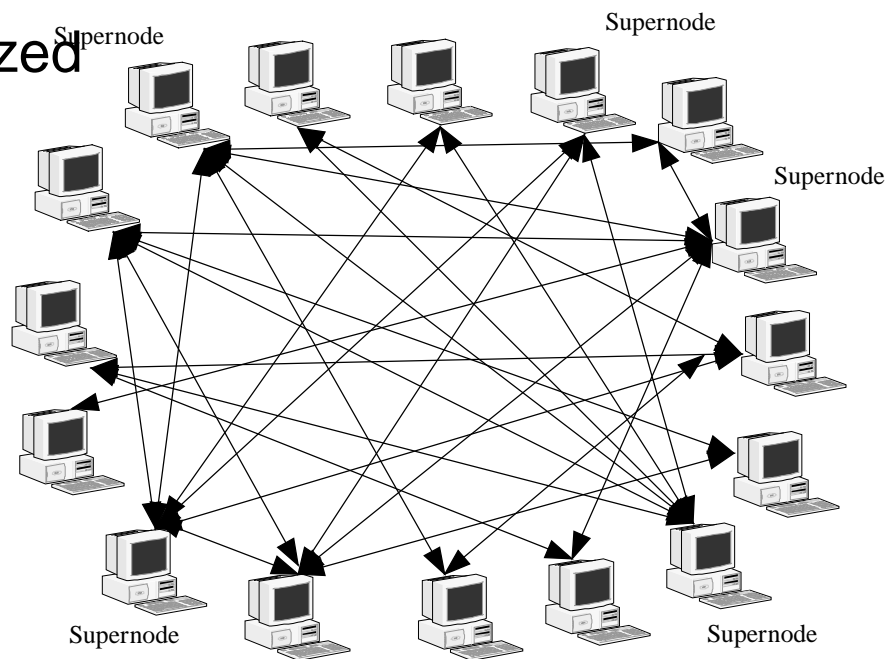

Peer to Peer types

- Central Index Server

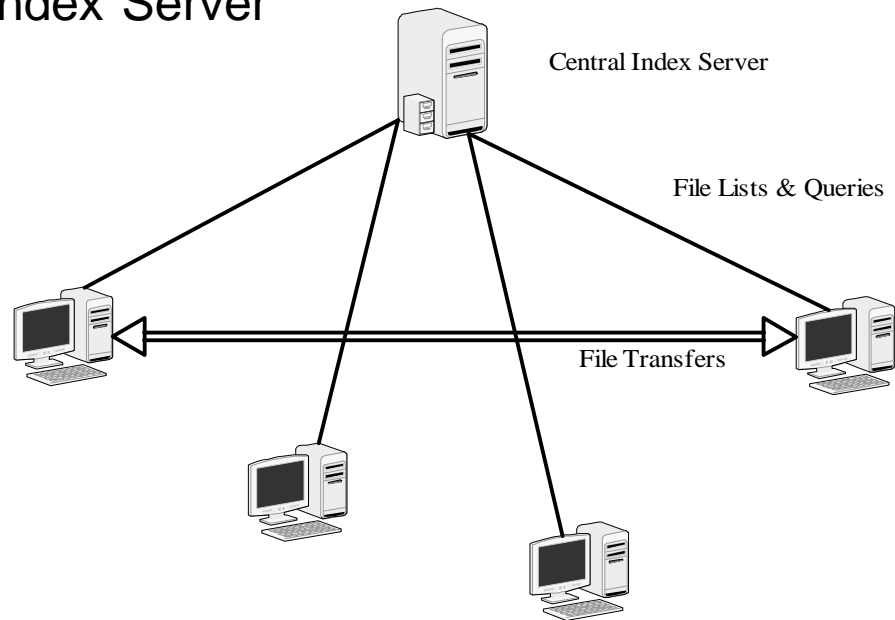

Dr. Doug Jacobson - Introduction to
Network Security - 2009

59

Napster

- Napster is a controversial application that facilitates the sharing of music files
- User's can search for songs and download songs from another user's harddrive
- All clients connect to a central server

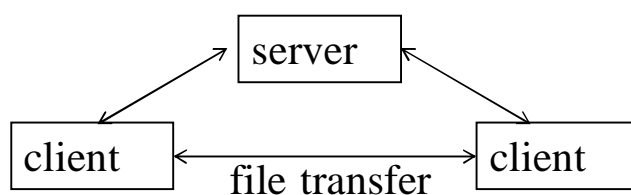

Dr. Doug Jacobson - Introduction to
Network Security - 2009

60

Napster

- Napster has a simple packet format:

Length	Type	Data
--------	------	------

- The length and type fields are each 2 bytes
- Types:

2	Login	203	Get
3	Login Ack	204	Get Ack
100	Notify	218	Download
200	Search request	219	Download complete
201	Search reply	220	Upload
		221	Upload complete

Napster

- Sequence:
 - Log in to server
 - Notify the server of files you are sharing
 - Search for a file to download
 - Download the file
- The above sequence is illustrated on the next slide.
- For now, assume the user is not behind a firewall

Napster

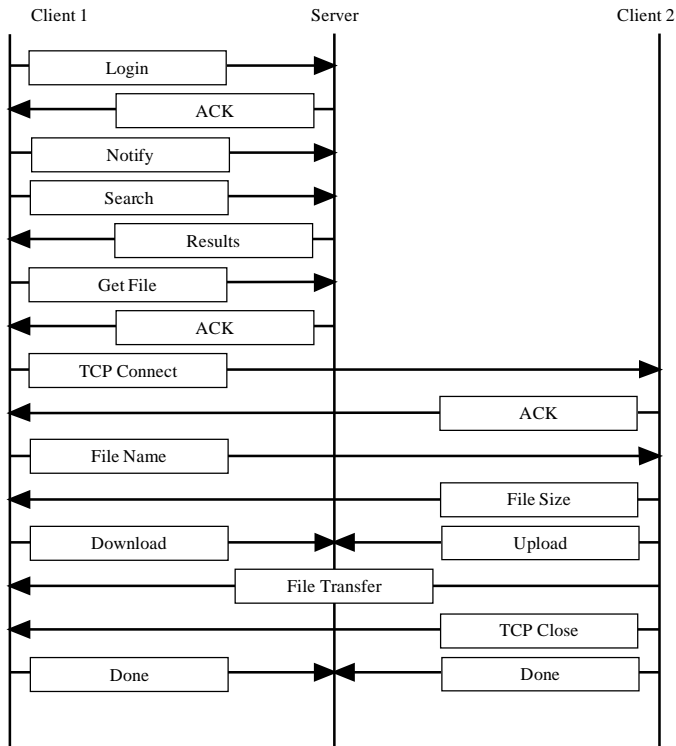

Length	Type	Data
--------	------	------

Dr. Doug Jacobson - Introduction to
Network Security - 2009

63

Napster

- When client 1 is behind a firewall, the download is slightly different
- Client 1 tells the server the port to use
- The server then tells client 2 which port to use
- Client 2 sends the file to the specified port

Dr. Doug Jacobson - Introduction to
Network Security - 2009

64

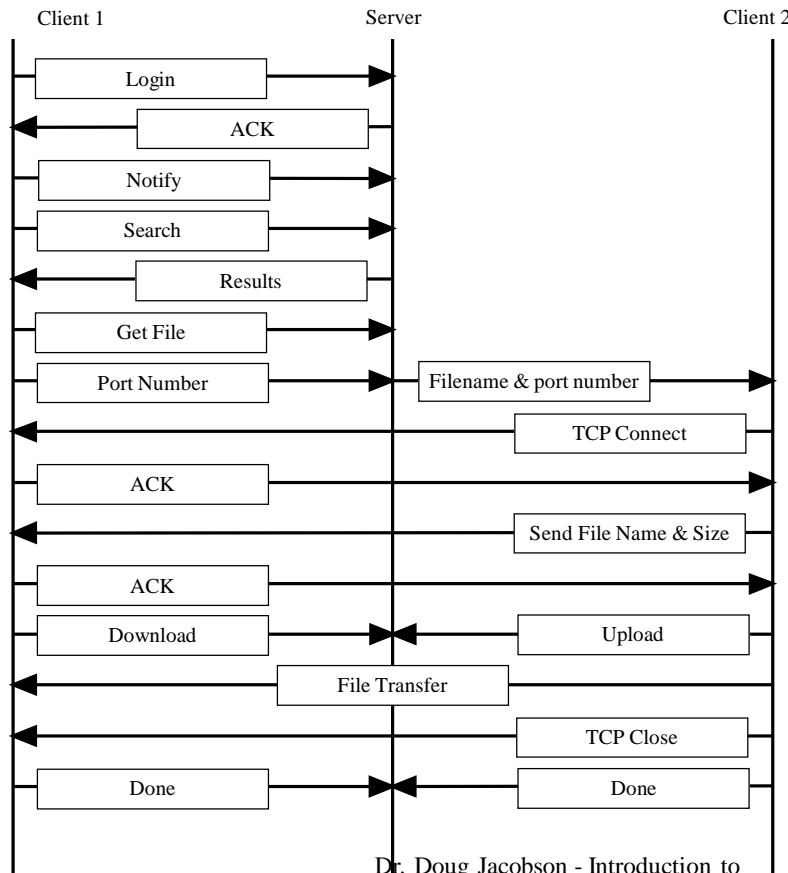

Napster

Dr. Doug Jacobson - Introduction to
Network Security - 2009

65

Napster Issues

- As shown in the preceding illustrations, the server is heavily involved in facilitating the transfer of files
- The server also keeps track of what is being transferred where
- This may have played a part in the case against Napster
- However, how can you verify that the filename accurately reflects the song transferred?

Dr. Doug Jacobson - Introduction to
Network Security - 2009

66

KaZaA

- Central Index server based (called super nodes)
- Uses Fasttrack protocol between server and client
 - Proprietary protocol
- All files have hash values
- Protocol between clients is HTTP 1.1

Dr. Doug Jacobson - Introduction to
Network Security - 2009

67

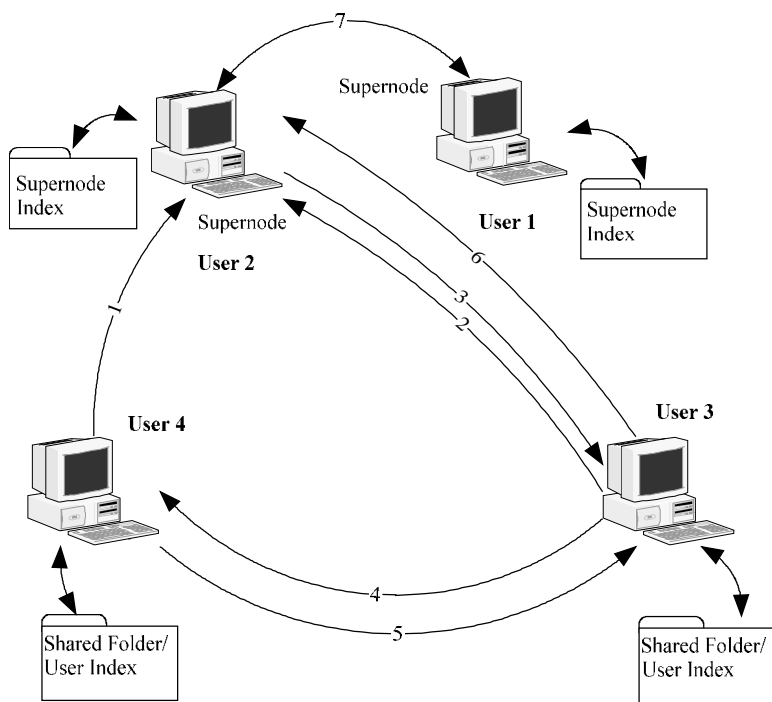

KaZaA

Dr. Doug Jacobson - Introduction to
Network Security - 2009

68

Decentralized Peer-to-Peer

- Limewire, Bearshare, Gnutella
- Peer-to-peer arrangement
- No central server
- Each client connects to 4 other clients, called servents
- Other clients connect to you
- Allows you to share and download any file type, not just music

Gnutella Protocol

- When you search for a file, you ask the servents nearest you, who ask the servents nearest them, and the search propagates in a daisy chain effect
- Logging in to the gnutella network generates a lot of traffic, as other people's searches are constantly propagating through you
- You can see what other people are searching for through you
- Gnutella clients are available for every platform. Some examples: BearShare, LimeWire

Gnutella Routing

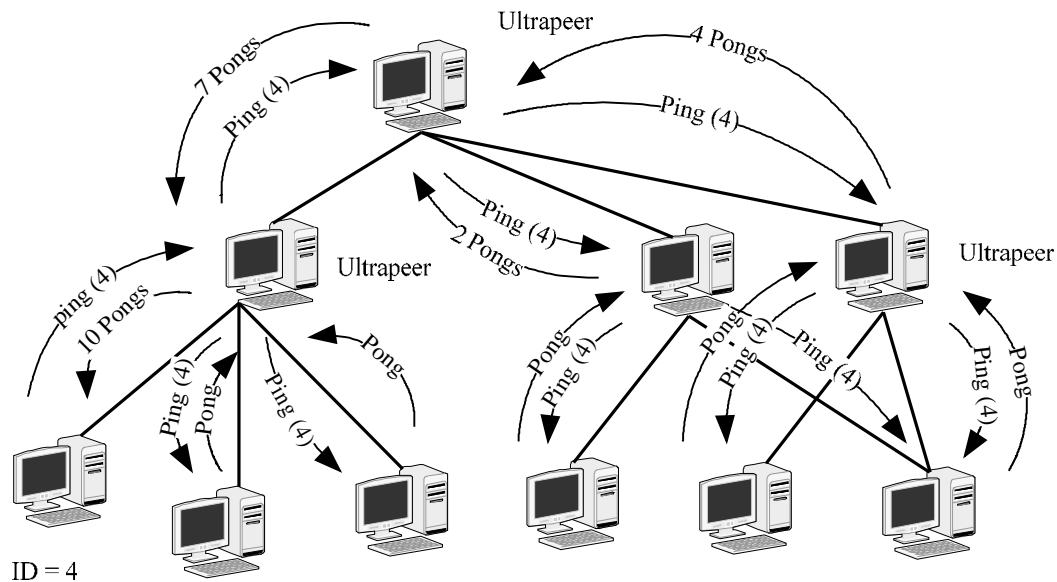

Dr. Doug Jacobson - Introduction to
Network Security - 2009

71

Gnutella Ping and Pong

- The data section of the “pong” packet contains:
 - Port number of responding machine
 - IP address
 - Number of files shared (4 bytes)
 - Total kilobytes shared (4 bytes)
- “Ping” packets contain no data
- Each client periodically pings all connections nearest them

Dr. Doug Jacobson - Introduction to
Network Security - 2009

72

Gnutella Queries

- The “query” packet contains:
 - Minimum speed in kb/s (2 bytes)
 - Search string (length varies)
- The “query-hit” packet contains:
 - Number of hits (1 byte)
 - Port (2 bytes)
 - IP address (4 bytes)
 - Speed (2 bytes)
 - Result set (length varies)
 - Index (4 bytes), Filesize (4 bytes), Name (length varies)
 - Servent name, used for push (generally the IP address)

Gnutella Packet Format

ID	Payload	TTL	Hop	Length	Data
----	---------	-----	-----	--------	------

Gnutella Packet

Payload	
00	ping
01	Pong
80	Query
81	Query Hit

Port	IP	Number of files shared	Number of bytes shared
------	----	------------------------	------------------------

Pong Packet

Min Speed	String
-----------	--------

Query packet

Hits	Port	IP	Speed	Results	IP
------	------	----	-------	---------	----

Query-Hit packet

Gnutella Push

- A “push” is used when the user is behind a firewall
- The “push” packet contains:
 - Servent ID
 - File index
 - IP address
 - Port

Header / Protocol Based

- Applications and protocol could be subject to these attacks.

Authentication Based

- Cannot trust source of files
- Anything can be shared
- Users that share can be traced

Traffic Based

- Can generate large amounts of traffic
- Super nodes can draw more traffic
- Sniffing is possible, but does not matter

Peer-to-Peer Countermeasures

- Port Blocking
- Content Blocking

Anonymous Services & Privacy Topics

- Anonymous services
 - Routing
 - Surfing
- Privacy on the Internet
- Proxy servers

Email Tracking

- www.readnotify.com
- Uses web bug tracking
- Keeps a log and emails you when the recipient opens the email.
- Looks like the email came from the sender, you send the email to:
 - user@domain.readnotify.com

Anonymous Email Services

- Login to a web site and send email from the site.
- Gmail, etc.
- Special sites for anonymous email
 - www.anonymousspeech.com

Privacy surfing the Internet

- Web servers can collect demographics about you
- www.privacy.net will show you all the things a webserver knows about you
- Examples:
 - Your browser type and Operating System
 - CPU type
 - whether JavaScript is enabled
 - Date/Time on your computer
 - Your IP address
 - Which plugins you have installed

Privacy on the Internet

- Once you login and give your email address, you are no longer anonymous
- Some web sites share your email address with other sites
- This can lead to you receiving spam from sites to which you've never disclosed your email
- Some sites store cookies on your harddrive. Amazon.com does this to recommend books based on your previous purchases.
- One way to surf privately: connect through a proxy

Proxy Servers

- A proxy is basically someone who makes requests on your behalf
- They were originally designed to cache information to prevent redundancy
- Suppose you (M) want to view a web page from server W. Here's how it would look without a proxy:

SIP = M S Port = ephemeral
DIP = W D Port = 80
URL=http://w.com/path

Proxy Servers

- Here's how it would look if you used a proxy server. Two different packets are needed: packet A is generated by yourself, and packet B is generated by the proxy server

Packet A: Packet B:
SIP=M SPort=? SIP=P SPort=?
DIP=P DPort=? DIP=W Dport=80
URL=http://w.com/path URL=http://w.com/path

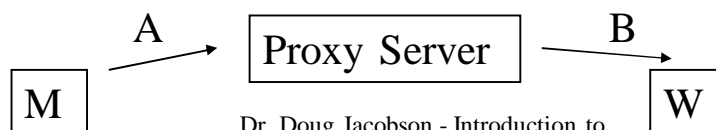

Proxy Servers

- There are two reasons to be anonymous
 - Don't want webservers to know who we are
 - Don't want big brother (ie: your boss) to know what sites we are visiting
- A proxy can provide some amount of anonymity
- Examples of existing proxy servers used to provide anonymity:
 - anonymizer.com, safeweb.com, kaxy.com, the-cloak.com
- However, if your company does not wish you to be using these proxies, they can block access to them through their firewall.

Secure Proxy Server

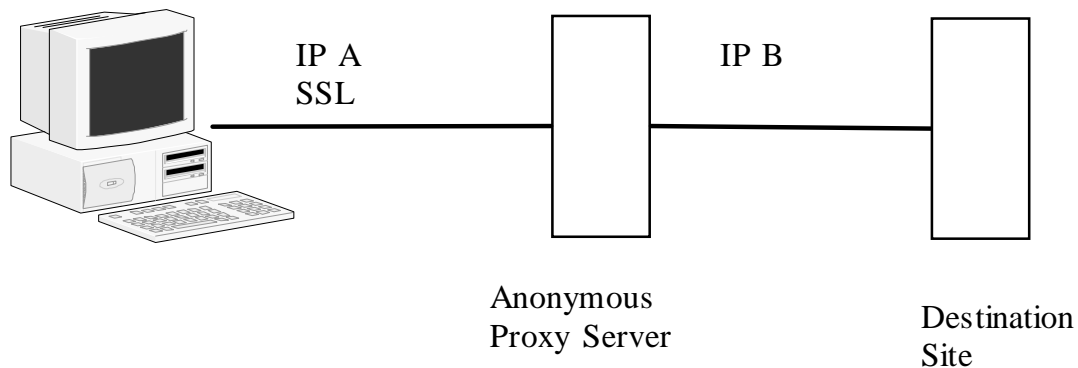

Proxy Servers

- However, TOR has a fix that prevents a company from blocking access to their site.
- It involves a system called onion routing
- See diagram next slide

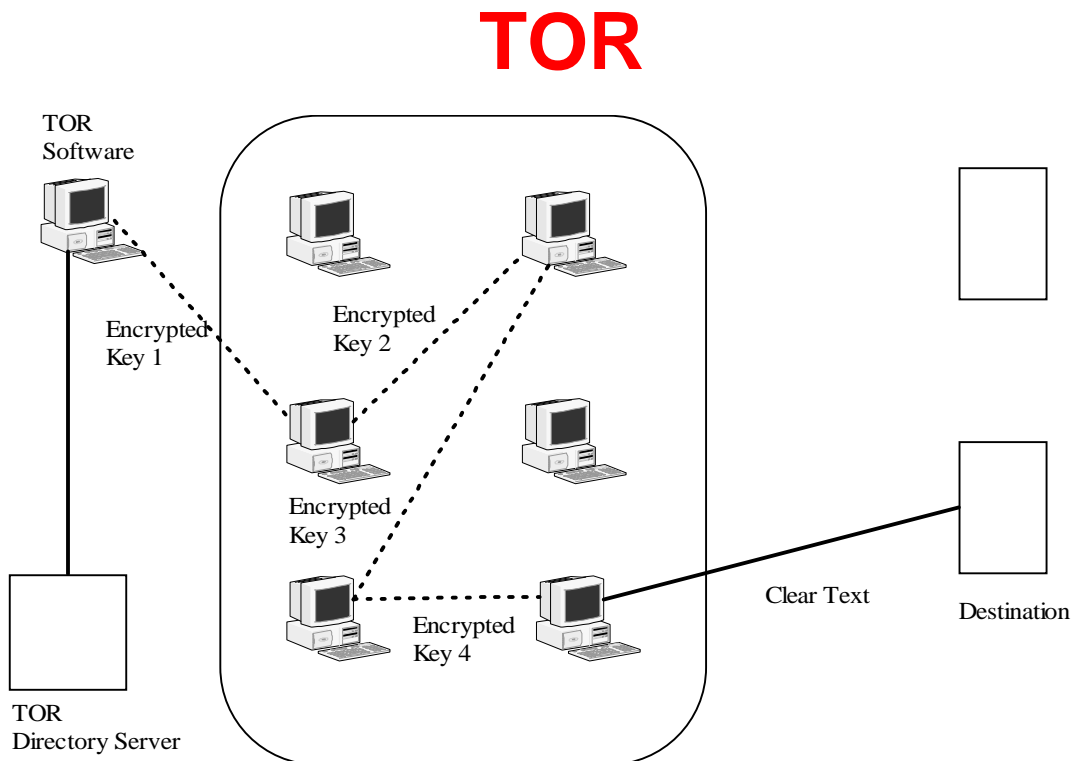

TOR

- Starting host builds the connection one node at a time.
- The encryption keys are between each node and the starting point, so each node is unable to read the data
- Once the end node is reached the starting node has a key with each node.
- Destination host only sees the last node

Security Issues

- Bypass company security policies
- Hard to stop

General Remote Access Countermeasures

- Encrypted remote access
 - Application-based
 - Tunnel-based
 - SSH
 - Remote desktop
 - Secure File transfer

Application-Based Encryption

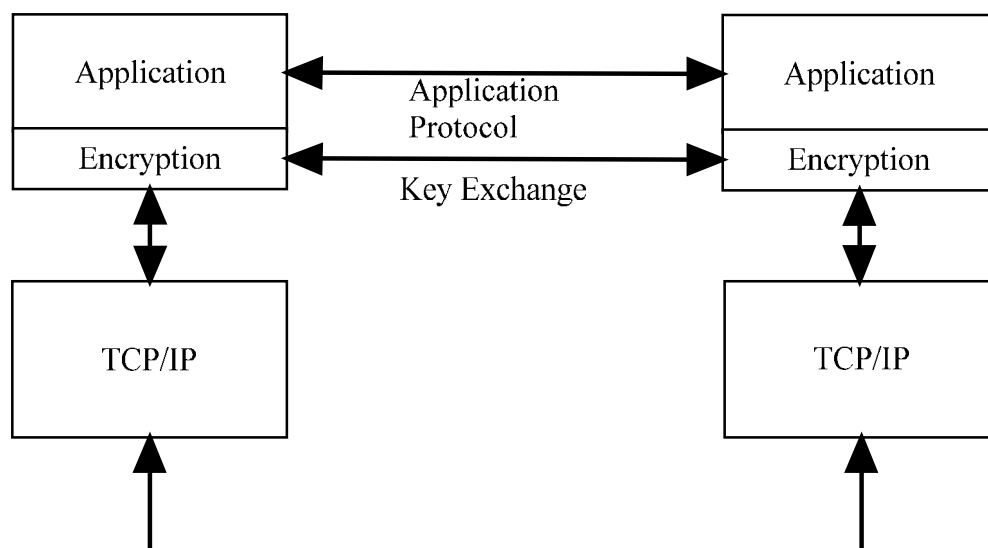

Tunnel-Based Encryption

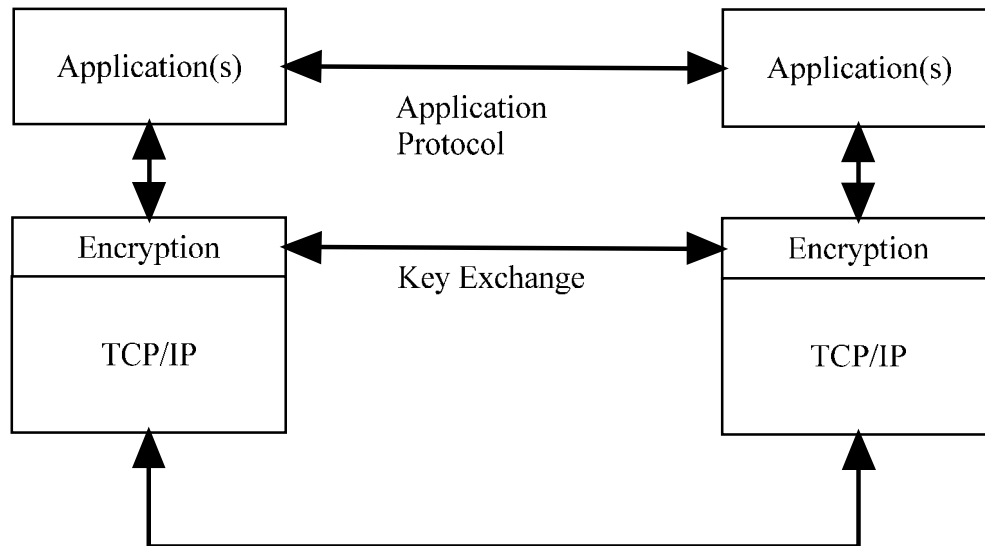

Encrypted Remote access protocols

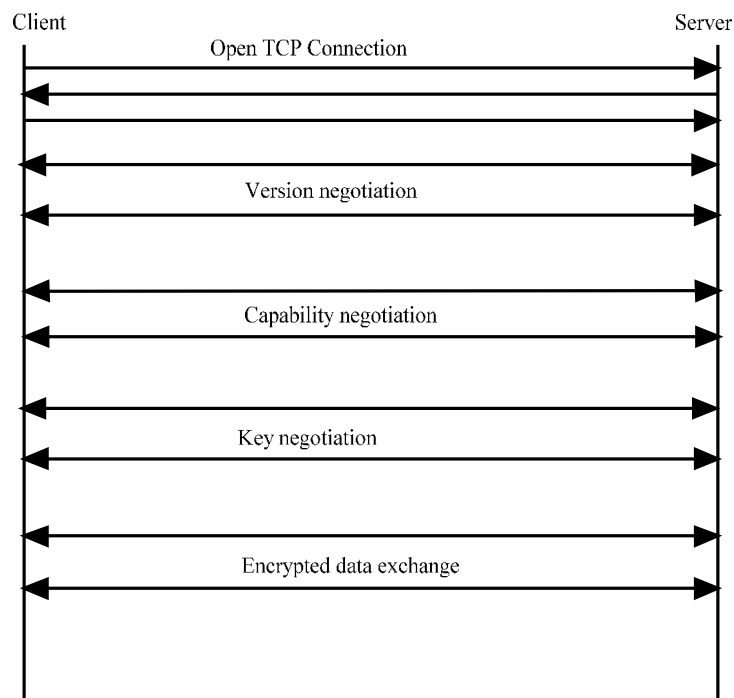

SSH

- SSH
 - Secure shell
 - Designed to replace rlogin, rsh, rcp
 - Provides
 - Authentication at the machine level, doesn't care about user authentication
 - Secure communication through encryption

SSH Details

- Strong Authentication
- Public domain software
- Some versions support compression of data
- Privacy
 - Key negotiation with symmetric key
 - Key exchange based on no trust of network
 - Multiple keys to deal with replay attacks
- Can provide secure X11 sessions
- Encrypt any traffic with SSH
- Same parameters as rlogin
- If other side doesn't support SSH drops to rlogin

Details cont...

- Need server and client software
- Sshd server demon software
- Ssh is the client software
- Ssh keygen
 - Generates host key
- Ssh agent
 - Uses public and private key technique to get process started

SSH Protocol

- Client sends query
- Server sends two public keys which is a 1024 bit client key and a server key which is a 768 bit key
- Server key recomputed every hour
- Client generates 256 bit random number which is the symmetric key, which is encrypted using the server and the host keys
- Server responds with ok which is encrypted with session key
- All traffic is now encrypted with session key
- Problems
 - Man in the middle attack
 - Putty is a man in the middle attack program

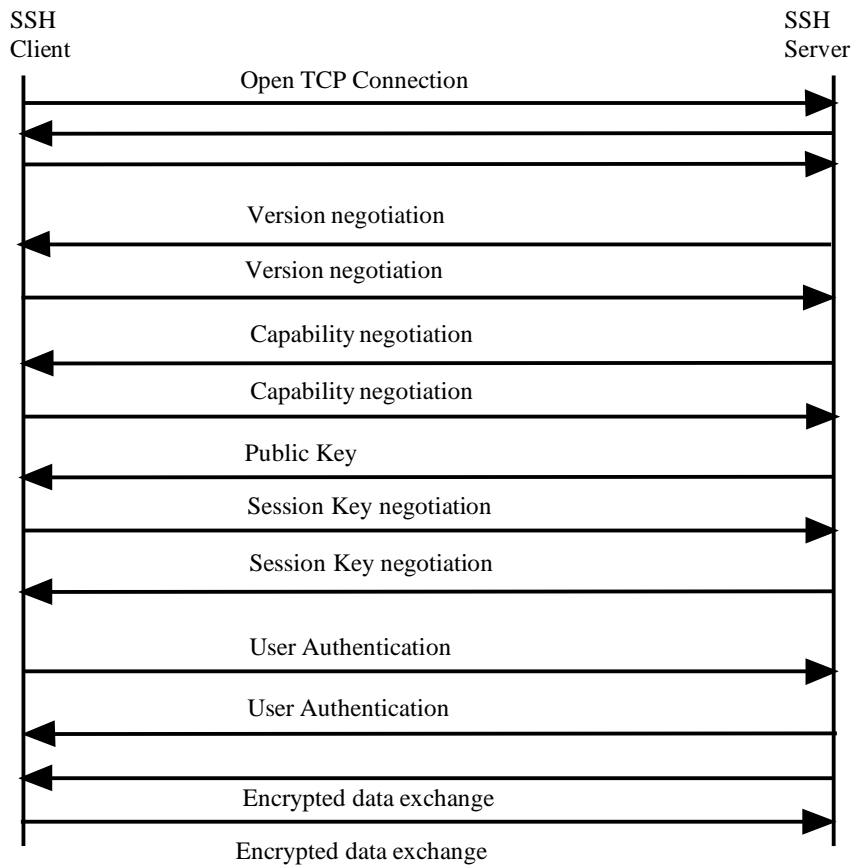

SSH

SSH Man in the Middle Attack

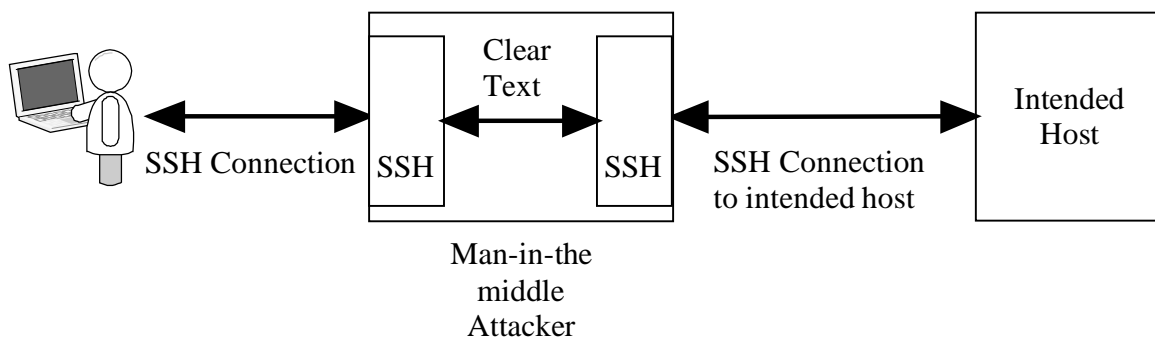

Remote Desktop

- Uses tunnel-based encryption
 - Via RDP or TLS (newer versions)
- Key exchange is similar to SSH
- Three levels
 - High (128 bit)
 - Medium (56 or 40 bit)
 - Low (56 or 40) only client to server data
- Subject to password guessing and man in the middle attacks

Secure File Transfer

- SFTP – uses SSH
- FTPS – uses SSL/TLS
- HTTPS – uses SSL/TLS