

Introduction to Network Security

Chapter 3

The Internet

Dr. Doug Jacobson - Introduction to
Network Security - 2009

1

Topics

- The Internet
- Addressing
- Client Server
- Routing

Dr. Doug Jacobson - Introduction to
Network Security - 2009

2

The Internet

- User's View

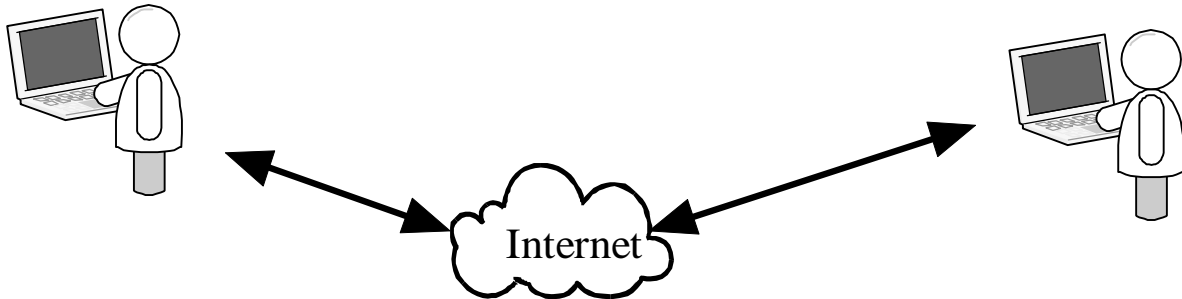

The Internet Hierarchy

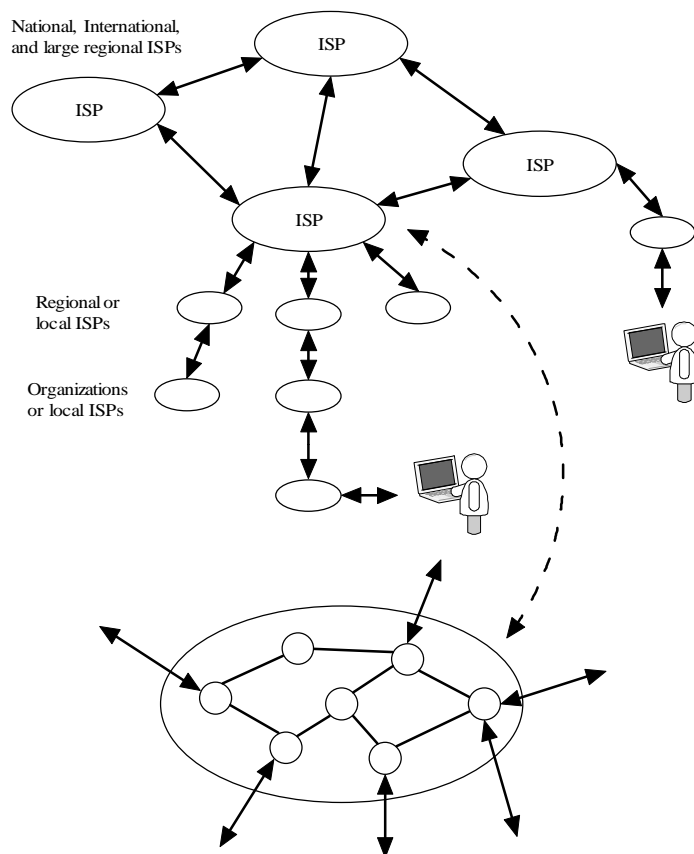

Internet Addressing

- Different address types
- Hardware address spoofing
- IP address Spoofing
- IP address Space

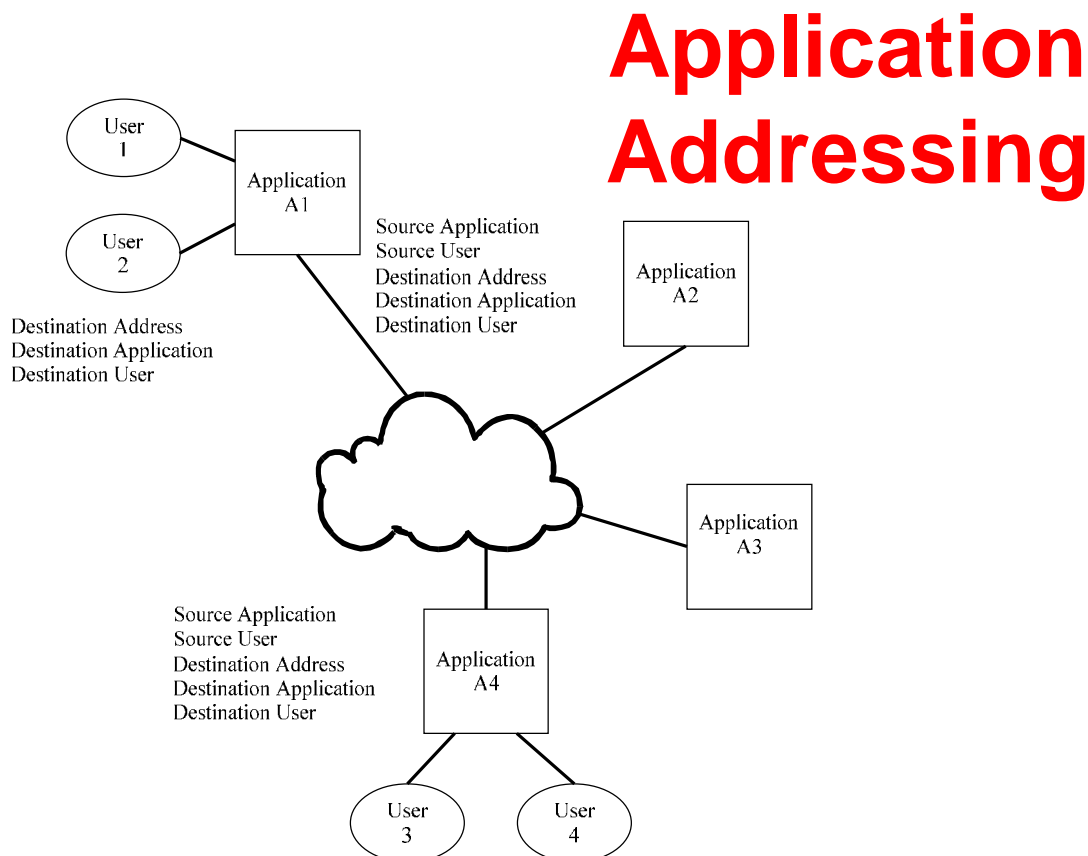

Different Address Types

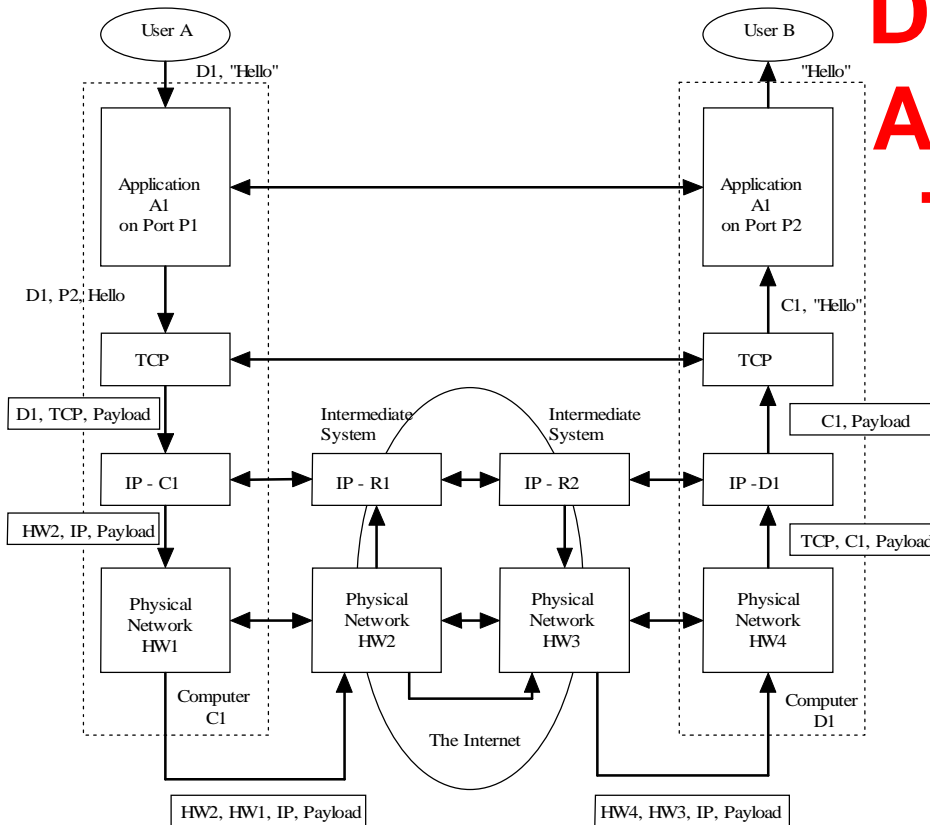

Dr. Doug Jacobson - Introduction to
Network Security - 2009

7

Address spoofing

- Who can generate the address?
- Spoofing is the ability to change the address
- Who can "see" (sniff) the traffic?

Dr. Doug Jacobson - Introduction to
Network Security - 2009

8

IP address Spoofing and Sniffing

Message will get to John

Return message will go back to Alice

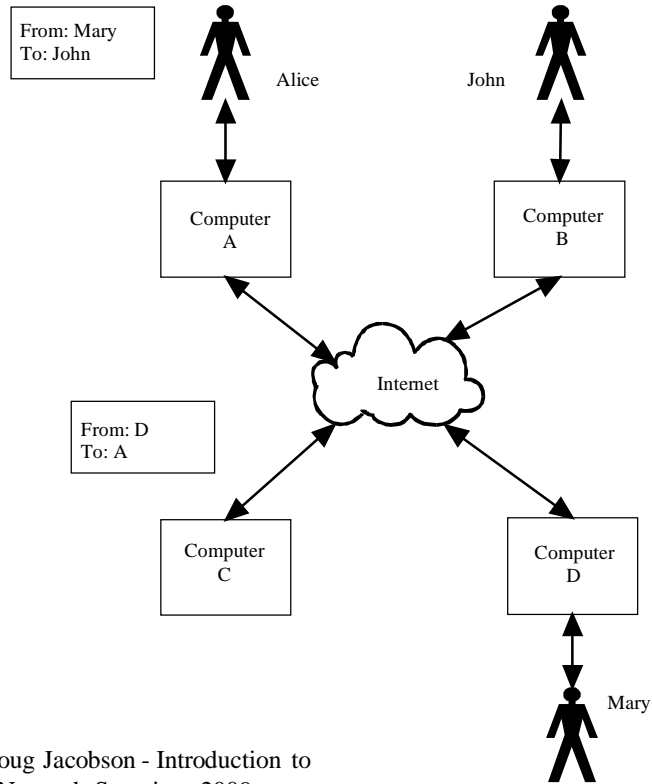

Dr. Doug Jacobson - Introduction to
Network Security - 2009

9

IP Address Space

- In Version 4 the IP address is 32 Bits
- Total IP address space is 4,294,967,296

IP addresses

- The IP address is written as a four-tuple where each tuple is in decimal and are separated by a "." (called a dot). When talking about an address you pronounce the word dot. So 129.186.5.102 is pronounced 129 dot 186 dot 5 dot 102

IP Addressing

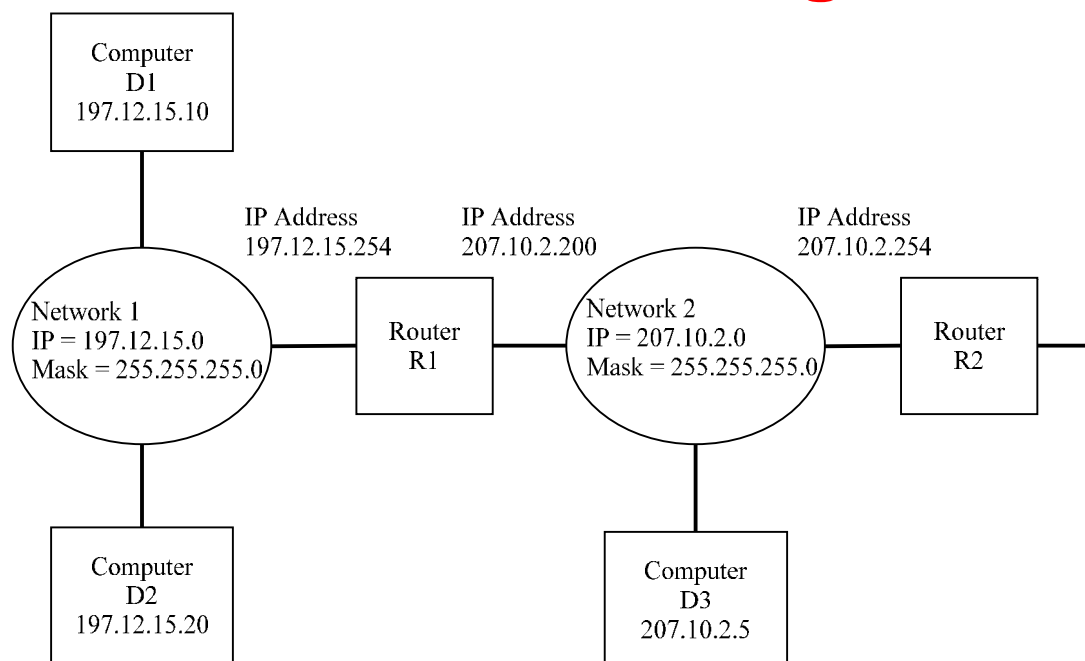

Figure 3.5 Networks in the Internet Dr. Doug Jacobson - Introduction to
Network Security - 2009

Machine names

- The format for the machine name is:
 - machine.domain Where:
 - machine is unique to the domain or subdomain.
 - and domain is a single domain or a series of subdomains.

Domain Name Conversion

- Now lets look at how we can convert a machine name into an IP address.
- There are two ways that this conversion can take place.
 - The first is to use a table on each host which maintains the mapping between names and IP addresses. This method required very large tables and made it hard to update.
 - The second, and preferred, method is to use a nameserver. The nameserver is actually a set of nameservers each having authority over different domains and subdomains.

DNS Model

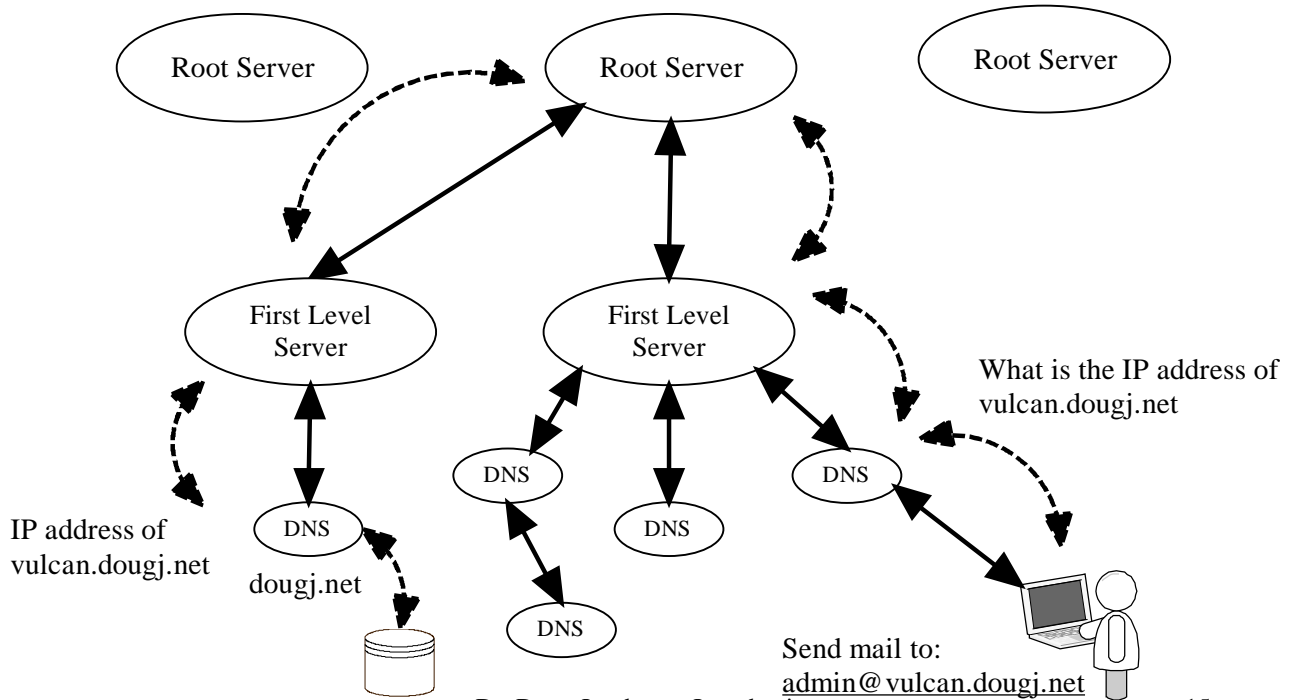

Dr. Doug Jacobson - Introduction to Network Security - 2009

15

Client Server Model

Full name: server.dougj.net
 IP address:
 Listening Port: 80

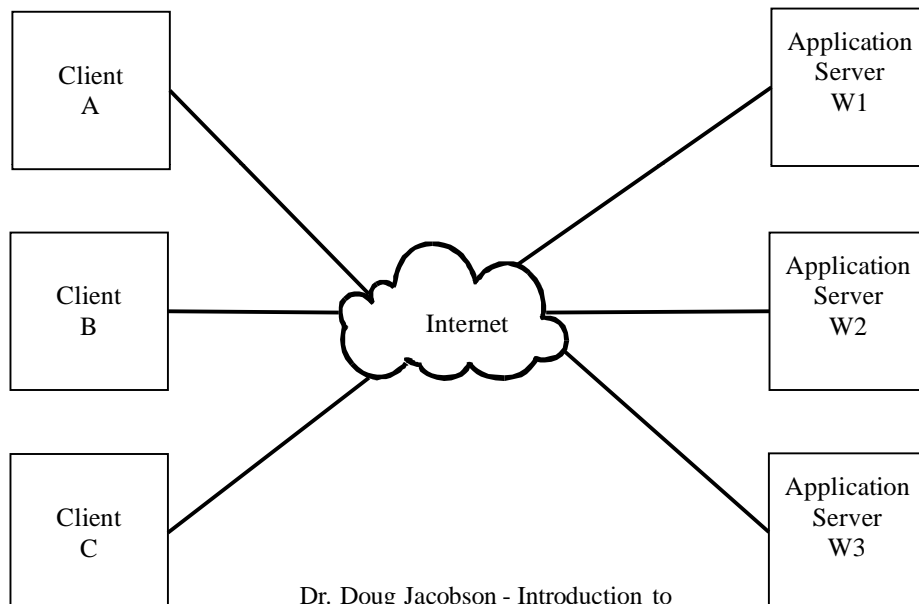

Dr. Doug Jacobson - Introduction to Network Security - 2009

16

Client Server model

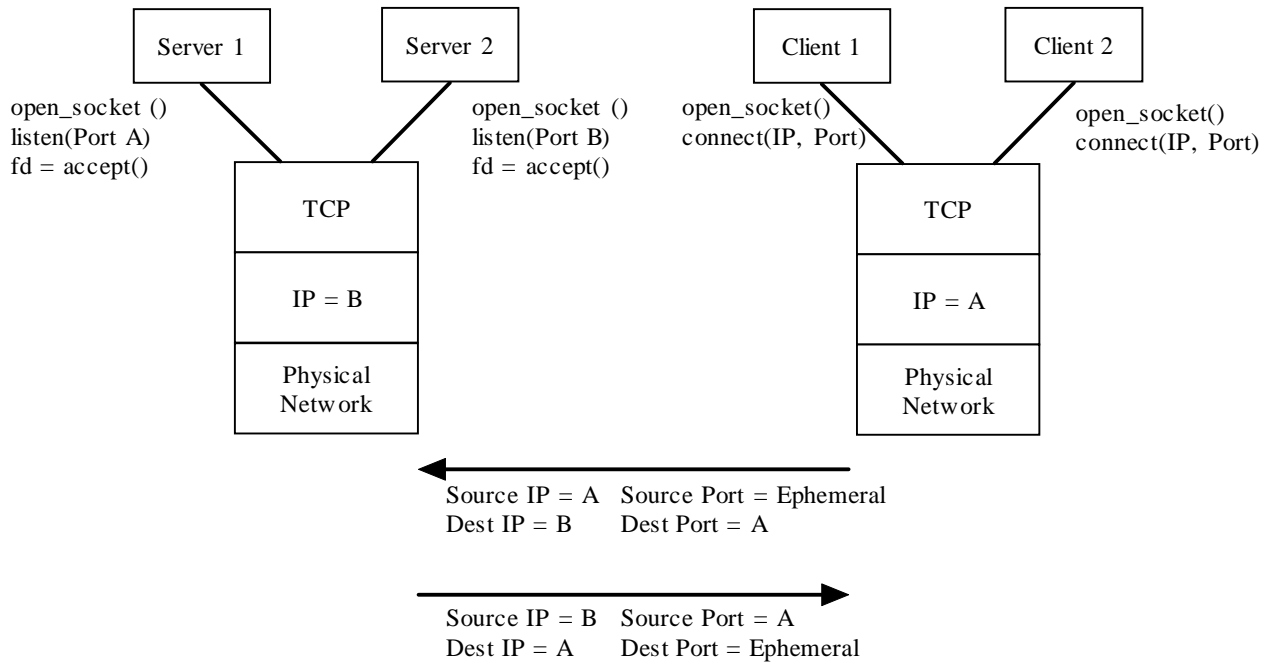

Dr. Doug Jacobson - Introduction to
Network Security - 2009

17

Client Server Model

Packets from client to server	
Source IP	Client's IP address
Destination IP	Server's IP address
Source Port	Ephemeral port
Destination Port	Server's port number (often well known)
Packets from server to client	
Source IP	Server's IP address
Destination IP	Client's IP address
Source Port	Server's port number (often well known)
Destination Port	Ephemeral port

Dr. Doug Jacobson - Introduction to
Network Security - 2009

18

Multiple Connections

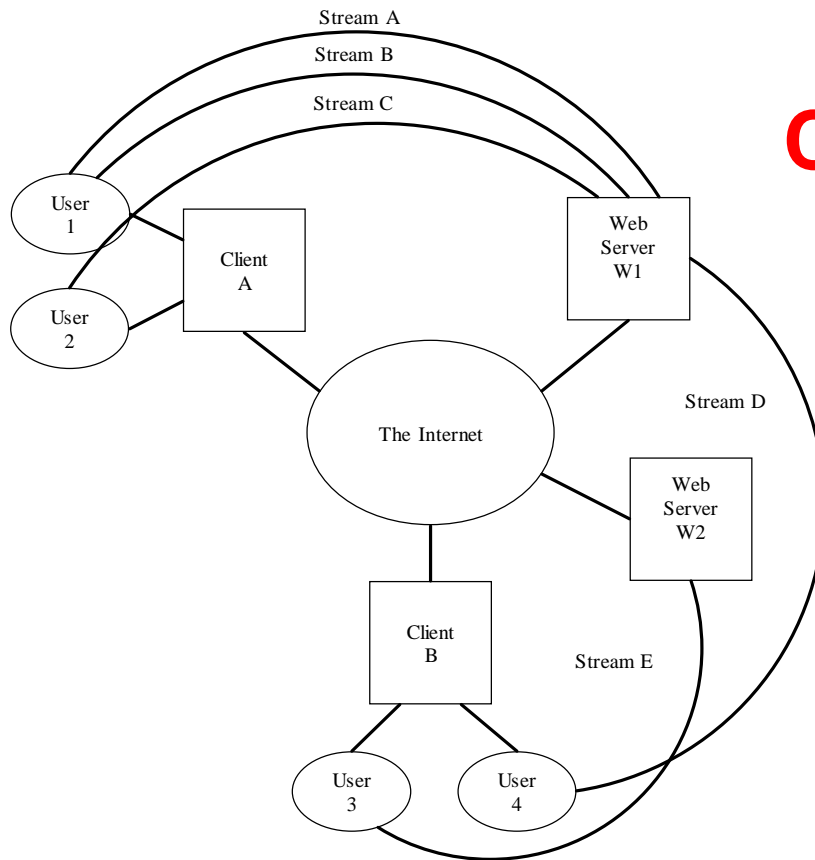

Dr. Doug Jacobson - Introduction to Network Security - 2009

19

Multiple Connections

Stream	Source IP	Destination IP	Source Port	Destination Port
A	A	W1	Ephemeral A1	80
B	A	W1	Ephemeral A2	80
C	A	W1	Ephemeral A3	80
D	B	W1	Ephemeral B1	80
E	B	W2	Ephemeral B2	80

Dr. Doug Jacobson - Introduction to Network Security - 2009

20

Routing

- All hosts and gateways store routing tables
- Each row in the route table contains:
 - Destination address or address range
 - Next hop for that destination address range
 - The physical interface to use for that address range. (ie: which Ethernet card to use)

Example: **Destination** **Next** **Interface**
 129.186.4.0 129.186.5.254 en0

Routing

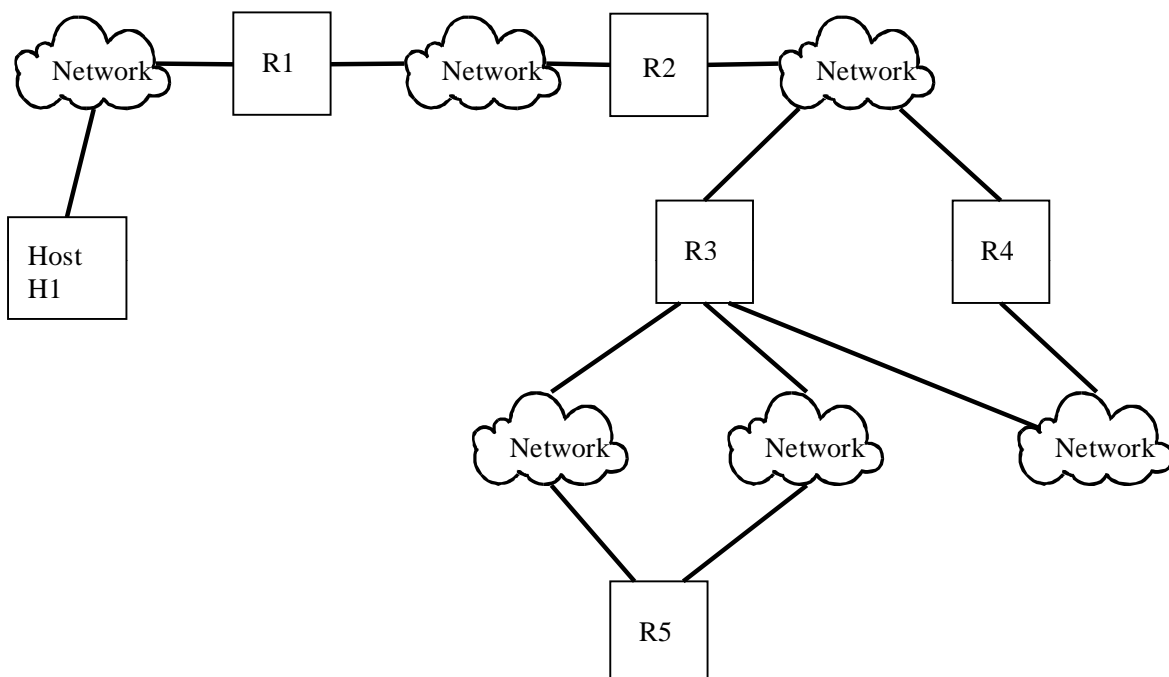

Dynamic vs Static

- Static
 - Tables built at system configuration time.
 - Used in small networks or networks with only one way out
- Dynamic
 - Tables are modified based on network parameters
 - Used in larger networks with multiple paths

Routing Example

Destination	Next Hop
Network 1	Direct
Default	Router R1

